

Pulse compression applied to determining hardening depth by ultrasonic backscatter method in wind turbine bearings

Héctor CALAS¹, Ewen CARCREFF¹, Amaia ALBERDI², Jean-Philippe GAUDIAU¹

¹ TPAC, Nantes, Frankreich

² RENOGEAR, Azkoitia, Gipuzkoa, Spanien

Kontakt E-Mail: hector.calas@tpac-ndt.com

Kurzfassung

A critical point in the manufacture of wind turbine bearings is surface hardening whilst their cores remain in the original structural condition. Surface hardness and case-depth measurements are the most important parameters for quality monitoring of surface hardened steel products. One of the techniques commonly used to measure the depth of hardening is the ultrasonic backscatter.

Identifying the depth of the hardness zone can be complicated if it is confused with the transition zone. And being able to accurately determine this depth can be the difference between a piece passing the regulations and being acceptable or not.

In this work we present a pulse compression method, based on the arbitrary wave generation (AWG) capabilities of the Pioneer device, to improve the contrast between the transition zone and the hardness zone. The results obtained in mockups and real pieces are presented.



H. Calás¹, A. Alberd², E. Carcreff¹ and J-P.Gaudiau¹.

¹TPAC, 13 rue du bois Briand, 4430 Nantes, FRANCE

²Renogear, Polígono Industrial Ugarte 144, Apdo. 94 E 20720 AzkoitiaGIPUZKOA (SPAIN)

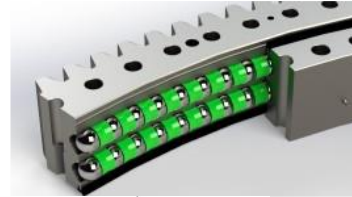
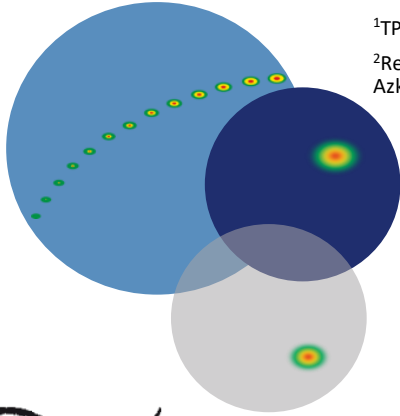

AOS & TPAC | Abstract

Abstract :

A critical point in the manufacture of wind turbine bearings is surface hardening whilst their cores remain in the original structural condition. Surface hardness and case-depth measurements are the most important parameters for quality monitoring of surface hardened steel products. One of the techniques commonly used to measure the depth of hardening is the ultrasonic backscatter.

Identifying the depth of the hardness zone can be complicated if it is confused with the transition zone. And being able to accurately determine this depth can be the difference between a piece passing the regulations and being acceptable or not.

In this work we present a pulse compression method, based on the arbitrary wave generation (AWG) capabilities of the Pioneer device, to improve the contrast between the transition zone and the hardness zone. The results obtained in mockups are presented.

- Background
- Theoretical model
- Application
- Experimental setup
- Results
- Conclusions

- Background



Method base

Ultrasonic backscatter is considered an effective technique for measuring the case-depth of induction-hardened parts. This method involves applying high frequency ultrasonic waves in a range between 12 and 25 MHz to the material and detecting the time of flight between the surface of the hardened piece and the soft steel core. The wave first passes through the fine-grained hardened layer and then interacts with the underlying coarse-grained layer, as shown in the following figure.

Using transverse waves with a suitable angle of refraction, the backscattering method reacts directly to structural changes in the material.

$$h = \frac{t}{2} v_s \cos(\theta)$$



Limitation in the application

- Whether there is a transition structure in the material. The location of the limiting hardness and the location of the maximum backscatter present a deviation.
- there is a dead zone due to reflection on the surface. this makes it difficult to measure layers below 1.5 mm
- In cases where the transition zone is very large, backscatter already appears in this zone and complicates the measurement or makes it wrong.

In general, this type of measurement is carried out with conventional single element probes. In the present work we propose the use of PWI techniques, for the determination of the depth of hardening. The use of this technique presents the following advantages compared to the use of single element sensors:

- 1- At each measurement point an image can be displayed that simplifies the interpretation of the measurement and helps the inspector to know if the system configuration is correct.
- 2- Spatial averaging strategies can be applied to a single measurement point, which improves the precision of the measurement.
- 3- The use of pulse compression can improve the identification of the hardness zone by decreasing the influence of the transition zone.

• Theoretical model

AOS & TPAC | Theoretical model: Backscattering amplitude reflection

$$(1) \quad A(f, z) = A_0 e^{\alpha_s(f)z}$$

The measured grain backscattered echo is a composite signal corresponding to many reflected grain boundary echoes with random amplitudes and arrival times.

Based on linear system theory:

$$(2) \quad s(t) = u(t) * g(t)$$

Measurement signal

The ultrasonic pulse

Grain scattering reflection function

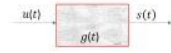

The grain scattering reflection function is different in each phase of the structure.

$$s(t) = u(t) * g_H(t) * g_T(t) * g_C(t)$$

Can be transformed into frequency domain

$$S(\omega) = U(\omega)G_H(\omega)G_T(\omega)G_C(\omega)$$

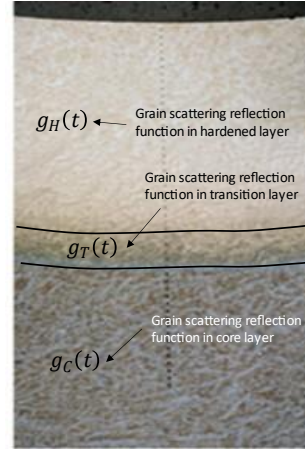

AOS & TPAC | Theoretical model: Pulse manipulation using AWG

$$s(t) = u(t) * g_H(t) * g_T(t) * g_C(t)$$

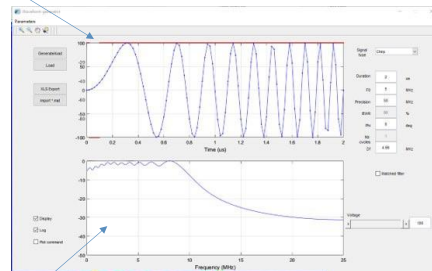
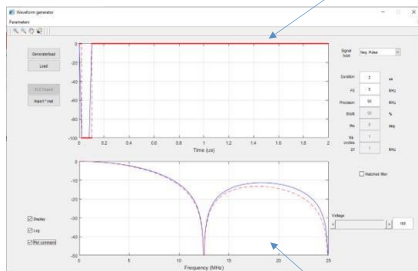

$$S(\omega) = U(\omega)G_H(\omega)G_T(\omega)G_C(\omega)$$

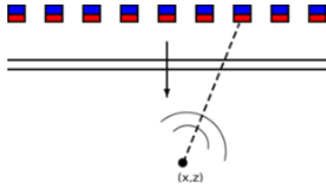

the amplitude values at each point of the image are obtained as follows

$$(9) \quad A(z, x, y) = \sum_i^N \sum_j^N s_{ij} (t_i(z, x, y) + t_j(z, x, y))$$

A spatial average will be performed on the XY plane, on a cell defined for each Z,

$$A(z) = \frac{1}{XY_z} \sum_l^{XY_z} \sum_i^N \sum_j^N s_{ij} (t_i(z, x, y) + t_j(z, x, y))$$

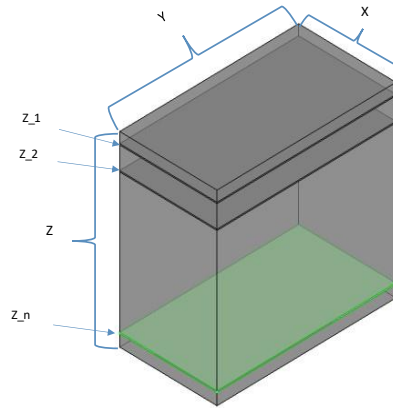

• Application

AOS & TPAC | Application

Although the presented method can be applied more broadly, in the present work we focus on a specific application that is measure layers in ball tracks, from ball $\varnothing 60$ up to 80mm balls.

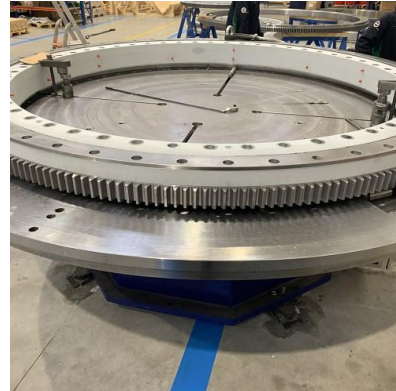
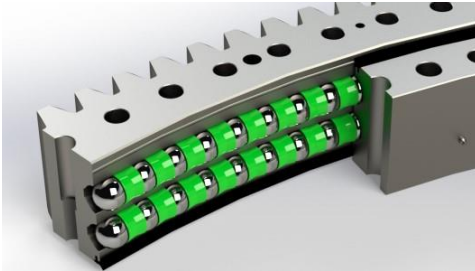

AOS & TPAC | Application

The purpose of the measurement is to record the depth of the induction hardening layers, it must detect the transition change of the layers from a hardness of 59+-4HRC to 500HV. Where the material is 42CrMo4+QT and must detect the transition from martensitic structure (structure obtained by induction hardening) to ferritic/bainite, tempered martensitic (structure we have in a forged ring)

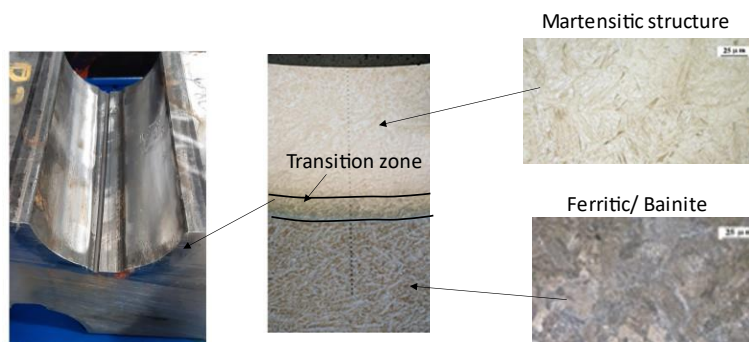

- Experimental setup

For the tests we have defined a mockup with the following characteristics:



Diameter: 76.2 mm
Case-depth: 8.5 mm

AOS & TPAC | Experimental setup: Transducer definition for this specific application

Considering the characteristics of the system, the following transducer was defined. To obtain a flat wave of 8 mm width in the first 15 mm of the piece. and with the idea of being able to create a valid image reconstruction up to a depth of 15 millimeters.

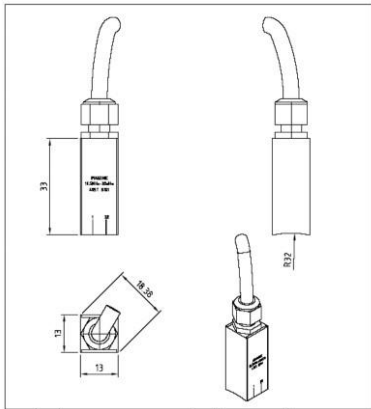

AOS & TPAC | Experimental setup: Probe holder and UT model

A probe hole was designed that adjusts the diameter of the part to ensure proper positioning of the sensor in all angular positions and avoid handling errors. The design allows to work in complete immersion, in local immersion or by adjusting a shaped wedge as long as it has the acoustic impedance of the water. The refracted angle in this case is 40 degree.

Mechanical model

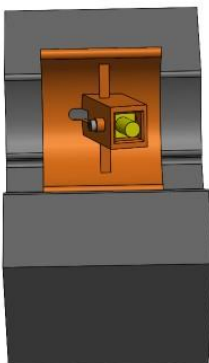

UT model in FastView

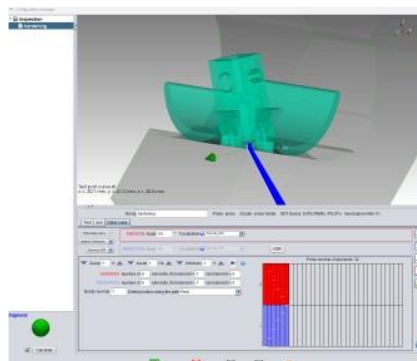

UT Inspection

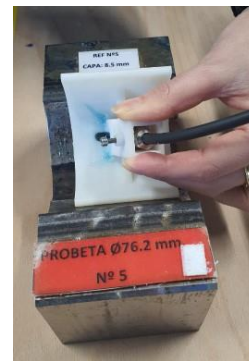

- Results

Conventional PAUT (FastView)

FastView Inspection conventional PAUT

Negative square pulse

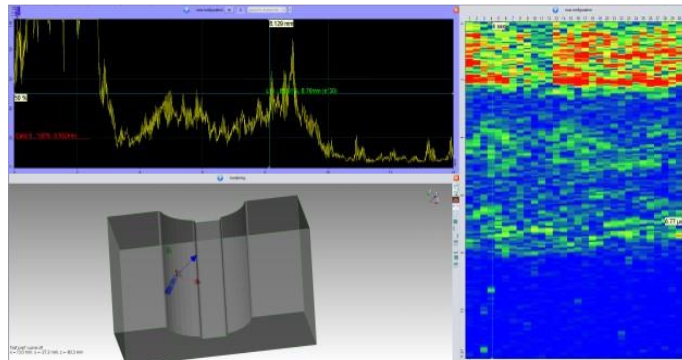
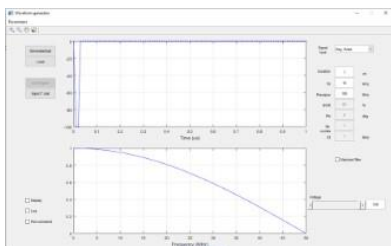

hardening-depth measurement: 8.1 mm

Negative square pulse

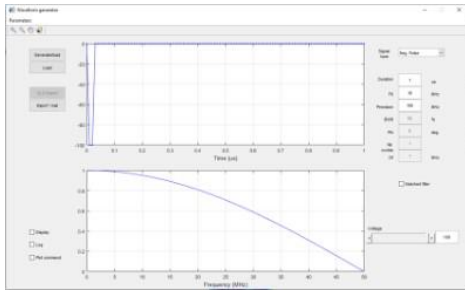

ARIA Inspection PWI evaluation in CIVA

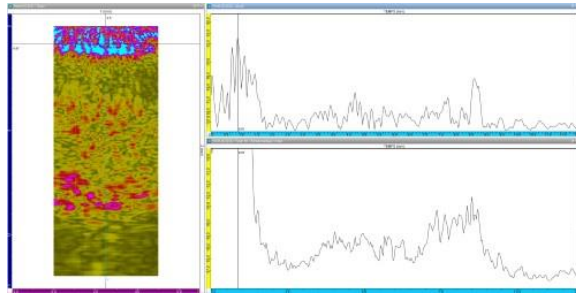

hardening-depth measurement: 7.5 mm confusion with the transition zone

A linear FM compressed (chirp) pulse excitation can be defined as:

$$e(t) = a(t)e^{j2\pi\left(f_0t + \frac{BW}{2T}t^2\right)}$$

Where $a(t)$ is the tapering function, f_0 is the central frequency, BW is the bandwidth of the chirp signal, and T is the signal duration. f_0 was 14 MHz, $T = 1 \mu s$, BW was 14 MHz. The signals is resented in Figure

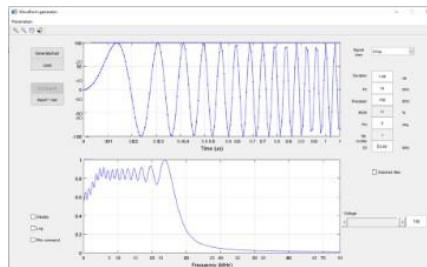

AOS & TPAC | Results: PWI + AWG (Chirp)

Compressed pulse

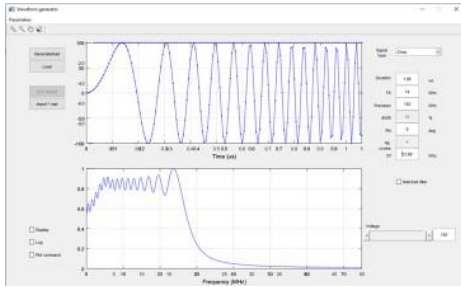

ARIA Inspection PWI evaluation in CIVA

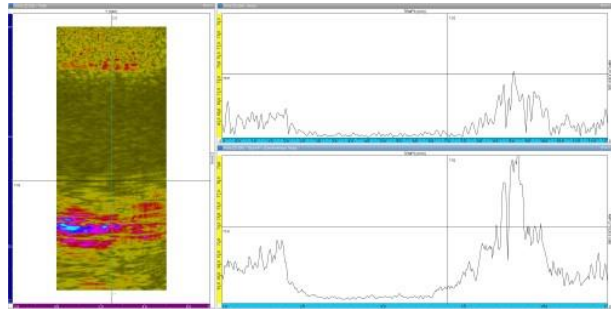

hardening-depth measurement: 8.6 mm the influence of the transition zone is significantly reduced

AOS & TPAC | Results: PWI vs PWI + AWG (Chirp)

Negative square pulse

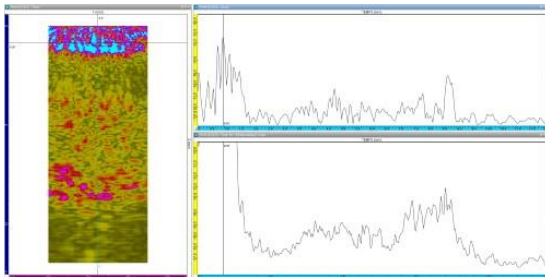

hardening-depth measurement: 7.5 mm

Compressed pulse

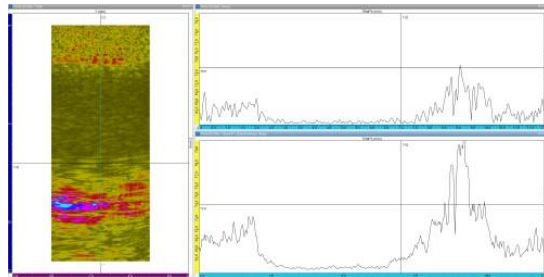

hardening-depth measurement: 8.6 mm

- Conclusions

The application of PWI techniques for the detection of the hardening depth presents good results in general. But in the transition zone, artifacts are generated in the image, which is difficult to identify if they are really the product of retroscpection or if they correspond to the reconstruction algorithms for this type of method. The application of a pulse compression technique in the appropriate frequency range allows to significantly reduction the influence of the transition zone reflection.

